

# Restraint Systems

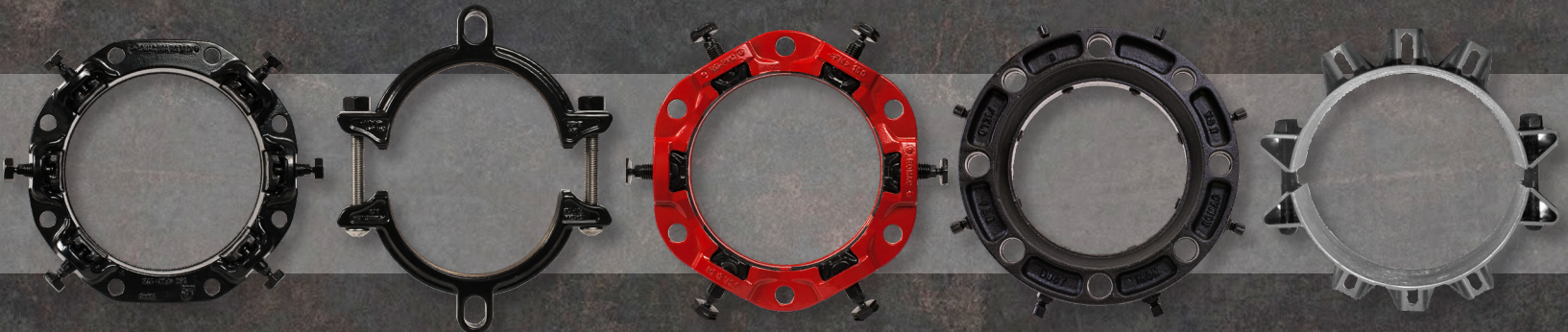

MECHANICAL JOINT RESTRAINTS • RESTRAINED FLANGED COUPLINGS  
FLEXIBLE EXPANSION JOINT • SPLIT PIPE RESTRAINERS  
RESTRAINT COUPLINGS • DISMANTLING JOINTS  
RESTRAINT GASKET • SPECIALTY RESTRAINT





### ROMAGRIP™ & PVC-ROMAGRIP™

#### Mechanical joint restraints

- Radial bolts have the same hex head as AWWA T-bolts, which means only one wrench is necessary for installation.
- Components are mechanically secure so they won't fall off during shipping, installation, or removal.
- No parts need to be removed from the PVC-RomaGrip to use it on either C900 or IPS PVC.
- RomaGrip sizes 3"–48"  
PVC-RomaGrip sizes 3"–24"
- For use on ductile iron, steel (3"–12"), and PVC pipe (see catalog for details).
- Sizes 3"–24" manufactured in the U.S.A.

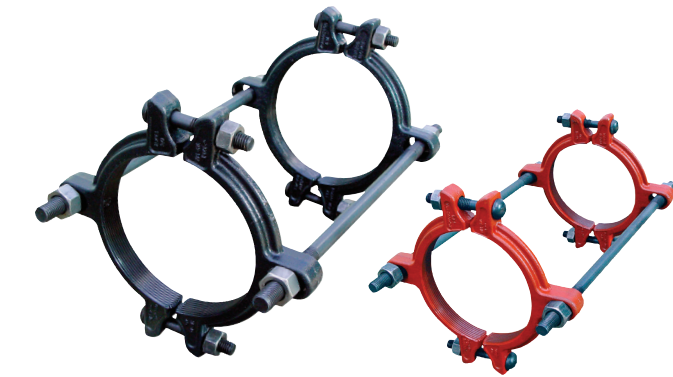

### 600™ SERIES

#### Pipe restraint system

- Pipe restraint for bell & spigot joints, transitions, couplings, and mechanical joints.
- For pipe sizes 4"–36"
- For use on ductile iron, C900, C905 and IPS size PVC pipe.
- Manufactured in the U.S.A., C905 imported.



### RFCA™

#### Restrained flange coupling adapters

- Provides a restrained flanged to plain-end connection.
- For pipe sizes 3"–24"
- For use on ductile iron, cast iron and 3-12 inch IPS Std. steel pipe (see catalog for complete details).
- Manufactured in the U.S.A.



### PVC-RFCA™

#### Restrained flange coupling adapters

- Provides a restrained flanged to plain-end connection.
- For pipe sizes 3"–24"
- For use on PVC pipe (see catalog for complete details).
- Manufactured in the U.S.A.



### GRIPRING™

#### Full circumferential mechanical joint restraint

- No radial bolts
- For pipe sizes 4"–12"
- For use on ductile iron, C900 and IPS size PVC.
- Manufactured in the U.S.A.

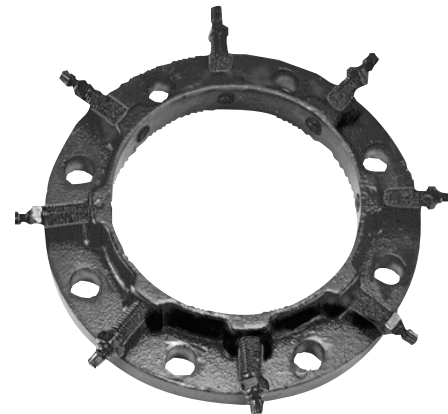

### FIELD FLANGE

- Used to join plain-end pipe to flanged fittings without threading or welding.
- For pipe sizes 4"–12"
- For use on steel and ductile iron pipe.
- Manufactured in the U.S.A.



### 400RG

#### Steel coupling

- Fully restrained steel coupling.
- Also available with a flanged end.
- For pipe sizes 12"–48"
- For use on ductile iron pipe.
- Manufactured in the U.S.A.

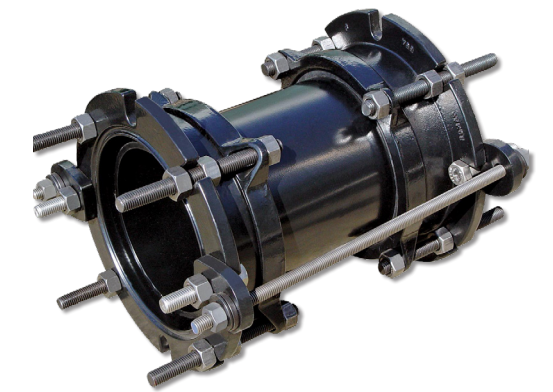

### ECF400

#### Equipment connection fitting

- Provide offset, deflection and restraint for systems with misaligned flanges.
- Allows deflection.
- For pipe sizes 3"–72"
- Manufactured in the U.S.A.

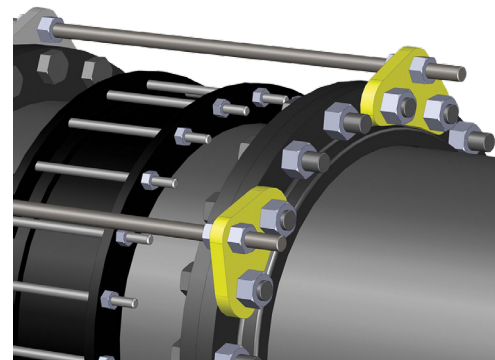

### 490 SERIES

#### Harness lugs & tie rods

- Provides restraint for flanged connections
- For pipe sizes 3"–72"
- For use on ANSI B16.1 Cls 125, ANSI B16.5 Cls 150, AWWA C207 Cls B, AWWA C207 Cls D, or AWWA C207 Cls E.
- Manufactured in the U.S.A.

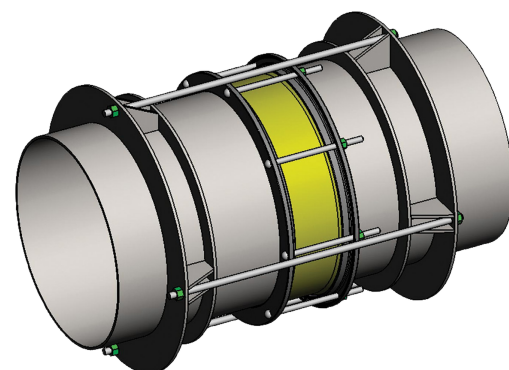

### AWWA M-11

#### Harness restraint

- Provides restraint for mechanical couplings on steel pipelines.
- For pipe sizes 6"–96"
- For use on steel pipe
- Manufactured in the U.S.A.

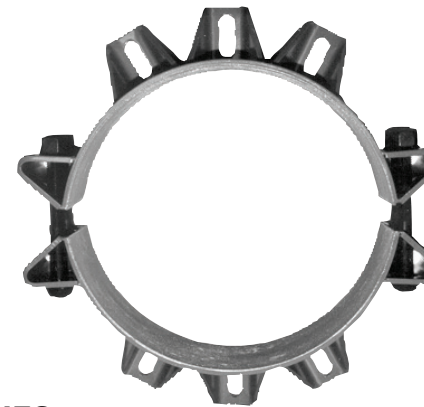

### 470 SERIES

#### PVC pipe restraint system

- Pipe restraint for mj fittings, bell and spigot joints, and bolted sleeve-type couplings.
- For pipe sizes 14"–30"
- For use on PVC C905 pipe.
- Manufactured in the U.S.A.



### PIRANHA

#### Restraint gasket

- For use only on ductile iron bell and spigot joints.
- For pipe sizes 4"–24"
- Manufactured in the U.S.A.



### ALPHA FC

#### Wide range, restrained flanged coupling adapter

- Fast, easy way to connect and restrain plain-end pipe to flanged fittings.
- For pipe sizes 4"–12"
- For use on ductile iron, cast iron, PVC & HDPE
- Manufactured in the U.S.A.



### ALPHA

#### Wide range pipe coupling with built-in restraint

- One piece, stab-fit installation.
- For use on ductile iron, cast iron, PVC & HDPE
- For pipe sizes 4"–12"
- Manufactured in the U.S.A.



### ALPHA EC

#### Wide range pipe end cap with built-in restraint

- Caps plain-end pipe for testing, blow-off or line flushing.
- For pipe sizes 4"–12"
- For use on ductile iron, cast iron, PVC & HDPE
- Manufactured in the U.S.A.

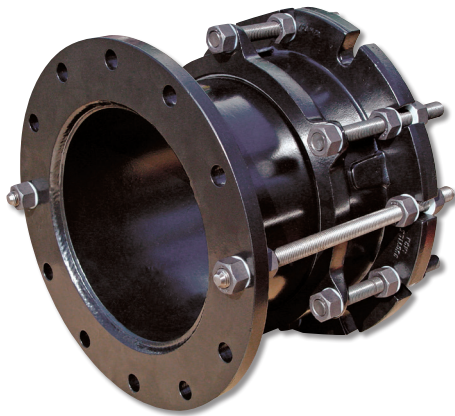

### DJ400

#### Dismantling joint

- Telescoping flanged fitting which can be shortened to allow room to access, or install valves and other fittings.
- For pipe sizes 3"–72"
- For use on ductile iron, steel, plastic and other types of pipe.
- Manufactured in the U.S.A.



### DJ405

#### Dismantling joint

- Telescoping flanged fitting which can be shortened to allow room to access, or install valves and other fittings.
- Allows deflection.
- For pipe sizes 3"–24"
- For use on ductile iron, steel, plastic and other types of pipe.
- Manufactured in the U.S.A.



### ARMOR LOCK

#### All stainless steel coupling with quick stab-fit installation

- Join and restrain plain-end pipe.
- Accommodates angular deflection, gaps between pipe ends.
- For pipe sizes 4"–12"
- For use on HDPE, PVC, steel, cast iron and ductile iron.
- Imported.



### FJ RESTRAINT

#### Flexible expansion joint

- Accommodates expansion, contraction, deflection and pipeline rotation all at the same time.
- Available with flanged, or mechanical joint ends.
- Double or single-ball configurations available.
- For use on ductile iron, steel, plastic and other types of pipe.
- Sizes 3"–24". Larger sizes available upon request.
- Manufactured in the U.S.A., larger sizes imported.

