



ALPHA™ RESTRAINED JOINT



ALPHA™ RESTRAINED JOINT

Features
PAGE 1-2



Wide Range Restrained Coupling

ORIGINALLY RELEASED IN THE SUMMER OF 2013, THE ALPHA COUPLING INSTALLS IN ABOUT THREE MINUTES, AND ACCOMMODATES UP TO 8 DEGREES OF DEFLECTION (4 DEGREES ON EACH END).

PAGE 1-4



Wide Range Restrained End Cap

THE ALPHA EC CAPS PLAIN-END PIPE FOR TESTING, BLOW-OFF OR LINE FLUSHING. THE ALPHA END CAP CAN ALSO BE USED AS A RELIABLE PIPE END SEAL FOR PERMANENT INSTALLATION.

PAGE 1-7



Wide Range Restrained Flanged Coupling

THE ALPHA FLANGED COUPLING QUICKLY ADAPTS PLAIN-END PIPE TO FLANGED FITTINGS. THE ALPHA FLANGED COUPLING ALSO ACCOMMODATES FLANGED SPOOL PIECES FOR CONNECTING TO VALVES AND OTHER FITTINGS.

PAGE 1-9



Wide Range Restrained Tee Fitting

ALPHA TEE RESTRAINED FITTINGS QUICKLY ADD A BRANCH CONNECTION OFF A MAIN LINE AND ARE FASTER TO INSTALL THAN A TRADITIONAL AWWA C153 MJ TEE.

PAGE 1-11

ALPHA™

WIDE RANGE RESTRAINED JOINT

ROMAC
INDUSTRIES, INC.

ALPHA™

WIDE RANGE RESTRAINED JOINT

ALPHA ADVANTAGES

- Standard Alpha covers IPS PVC through Ductile Iron pipe diameters.
- Alpha XL accommodates Ductile Iron through Oversize Cast Iron pipe sizes.
- Alpha can be configured to transition from IPS PVC up to Oversize Cast Iron pipe diameters.
- One piece, stab-fit installation.
- Cast components are high strength ductile iron.
- Working pressure: up to 350 PSI.
- Manufactured in the U.S.A.
- US Patent: 8,894,100 & 9,534,714
- Alpha products are approved for use on:
 - Ductile iron
 - Cast iron (Classes A, B, C & D)
 - PVC IPS size (Sch 40, Sch 80 & SDR 21)
 - PVC C900 and C909
 - HDPE size 4"-12": SDR 9, 11, 13.5 & 17, no pipe stiffeners required.





For other pipe materials, contact Romac.

NOTE: The 16" Alpha XL is not compatible with HDPE and the original Alpha (with black grippers) is not compatible with HDPE pipe.

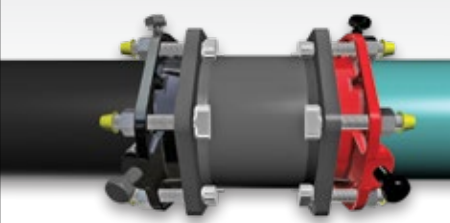
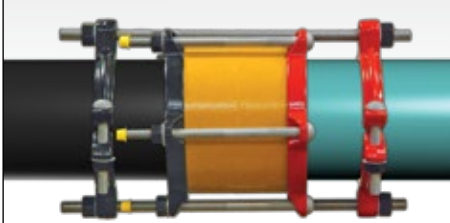

Certified to
NSF/ANSI 61 & 372

INSTALLATION TIME IS A FRACTION OF OTHER RESTRAINT METHODS

6" SLEEVE AND TWO MJ RESTRAINERS	6" COUPLING PLUS RESTRAINT SYSTEM	ALPHA
		
		
30 MINUTES TO INSTALL 29 TOTAL PARTS TO ASSEMBLE 12 T-BOLTS TO TORQUE 9 RADIAL BOLTS TO TORQUE 2 GASKETS TO SEAT	35 MINUTES TO INSTALL 33 TOTAL PARTS TO ASSEMBLE 5 COUPLING BOLTS TO TORQUE 4 CLAMPING BOLTS TO TORQUE 2 GASKETS TO SEAT	3 MINUTES TO INSTALL 2 NUTS TO TORQUE 1 PIECE (STAB-FIT) 0 GUESS-WORK



ALPHA™ WIDE RANGE RESTRAINED JOINT

KEY ALPHA COMPONENTS

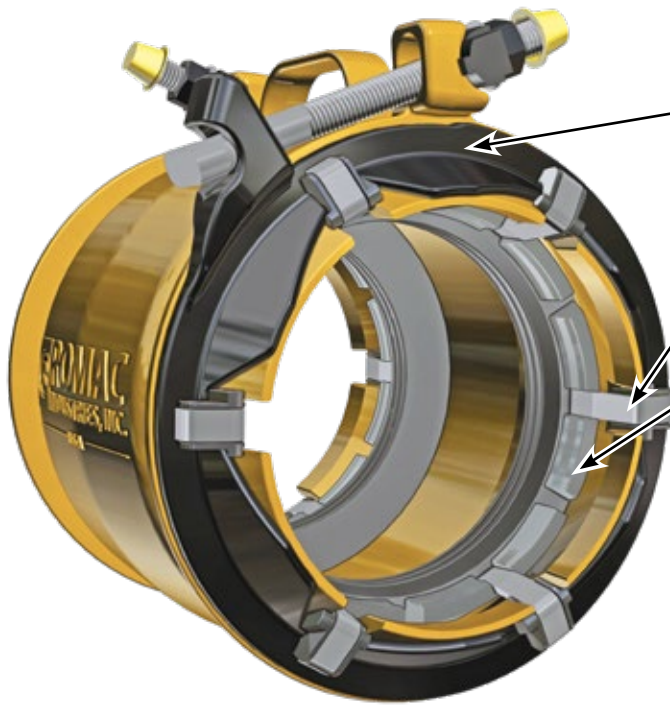

ROTATING END RINGS

- During installation, the end rings rotate and slide the draw hooks, gasket and grippers outward, against the pipe surface.

DRAW HOOK FASTENERS

- Stainless steel draw hooks are integrated into the gasket.

INDIVIDUAL GRIPPERS

- Individual ductile iron grippers compensate for angular deflection and out-of-round pipe.
- The grippers distribute the load evenly around the pipe circumference.

HOW ALPHA WORKS

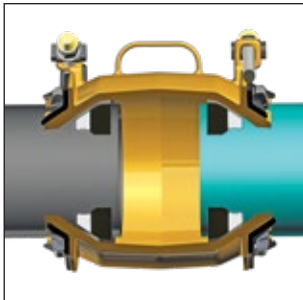

1 • Alpha is positioned over the pipe gap.

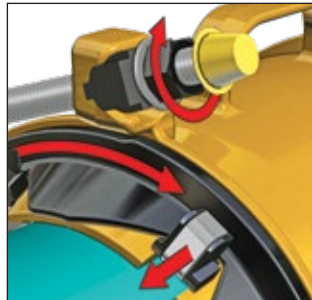

2 • Nuts are tightened, rotating the end ring.

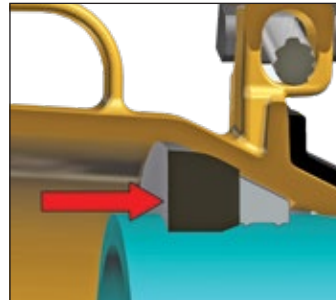

3 • Draw hooks pull gasket and grippers outward against the pipe.

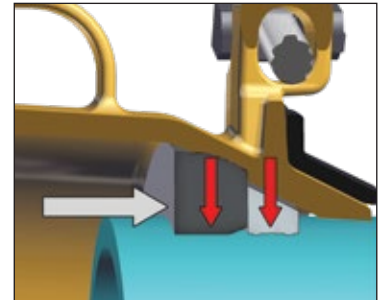

4 • Gaskets compress and seal against the pipe surface. Gripper teeth are set.

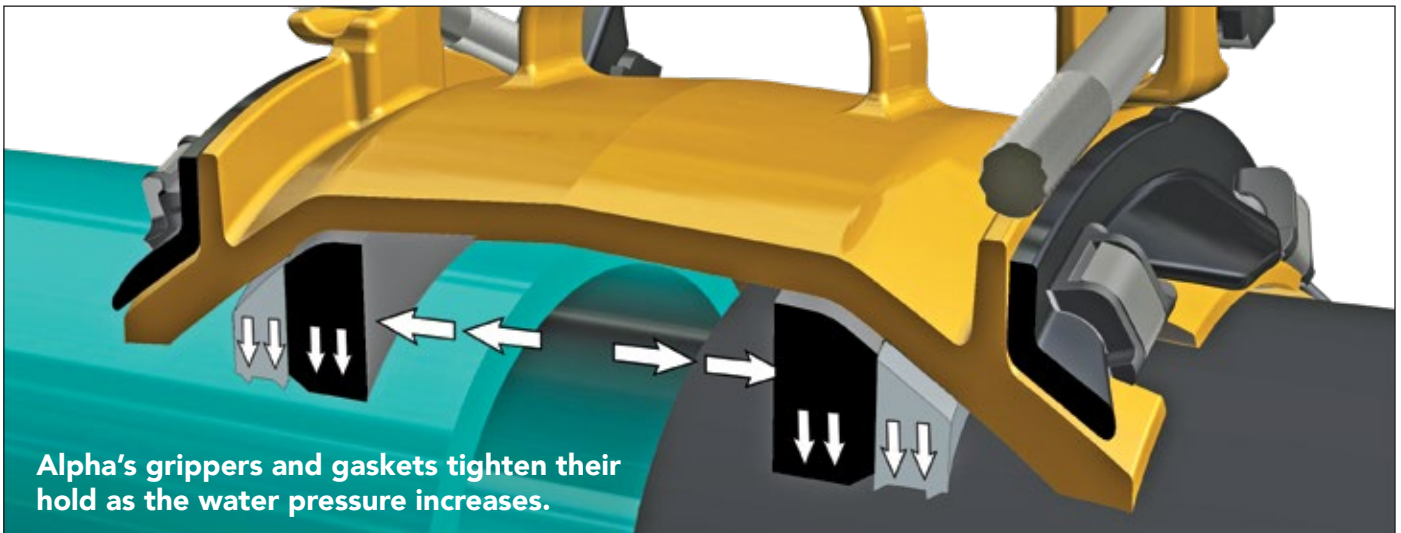

Alpha's grippers and gaskets tighten their hold as the water pressure increases.

ALPHA™ WIDE RANGE RESTRAINT COUPLING

ROMAC
INDUSTRIES, INC.

MATERIAL SPECIFICATIONS

CASTINGS: All cast components (end rings, center ring and bolt guides) are ductile iron, meeting or exceeding the requirements of ASTM A536, grade 65-45-12.

GRIPPERS: Ductile (nodular) iron, meeting or exceeding ASTM A536, grade 65-45-12. Machine sharpened and heat treated. Xylan 1424 coated for corrosion protection.

GASKET: SBR compounded for water and sewer service in accordance with ASTM D2000. NBR available upon request. NSF/ANSI 61 & 372 Certified.

DRAW-HOOK FASTENERS: 304L stainless steel.

RAMP RUNNERS: Reinforced nylon.

BOLTS & NUTS: 304 stainless steel, 5/8-11 bolts with heavy hex e-coated nuts. Fasteners provided with anti-galling protection.

COATINGS: Center ring Romacoat fusion bonded epoxy, NSF 61 certified. End rings are Romabond polyester.

WORKING PRESSURE: Up to 350 PSI.



STANDARD ALPHA
FITS IPS PVC THROUGH
DUCTILE IRON PIPE OD'S.



Certified to
NSF/ANSI 61 & 372



ALPHA™
RESTRAINED JOINT

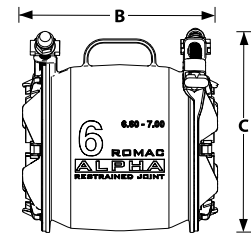
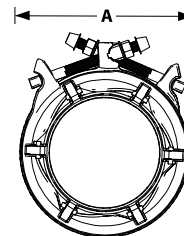

NOM. PIPE SIZE	O.D. RANGE (inches)	CATALOG NUMBER	DIMENSIONS			LIST PRICE	AP- PROX. WEIGHT (lbs)
			A O.D.	B LENGTH	C HEIGHT		
4"	4.50 - 4.90	ALPHA-A - 4.90	8.10	11.80	9.80	\$676.97	40
6"	6.60 - 7.00	ALPHA-A - 7.00	10.40	12.00	12.00	932.40	50
8"	8.60 - 9.10	ALPHA-A - 9.10	13.50	13.20	15.10	1,204.26	75
10"	10.75 - 11.20	ALPHA-A - 11.20	15.60	13.20	17.20	1,528.65	95
12"	12.75 - 13.30	ALPHA-A - 13.30	17.60	13.30	19.20	1,799.72	100

TO ORDER: Determine the O.D. of the pipes to be coupled, and select coupling size which covers the pipe diameters of both pipe ends. Specify Alpha Catalog Number [in table above]. Example: To couple 8" DI and 8" IPS PVC Pipe order **ALPHA-A-9.10**



ALPHA™ XL WIDE RANGE RESTRAINT COUPLING

MATERIAL SPECIFICATIONS

CASTINGS: All cast components (end rings, center ring and bolt guides) are ductile iron, meeting or exceeding the requirements of ASTM A536, grade 65-45-12.

GRIPPERS: Ductile (nodular) iron, meeting or exceeding ASTM A536, grade 65-45-12. Machine sharpened and heat treated. Xylan 1424 coating for corrosion protection.

GASKETS: 4"-12" NBR; 16" SBR. Gaskets compounded for water and sewer service in accordance with ASTM D2000. NSF/ANSI 61 & 372 Certified.

DRAW-HOOK FASTENERS: 304L stainless steel.

RAMP RUNNERS: Reinforced nylon.

BOLTS & NUTS: 304 stainless steel, 5/8-11 bolts with heavy hex e-coated nuts. Fasteners provided with anti-galling protection.

COATINGS: Center ring Romacoat fusion bonded epoxy, NSF 61 certified. End rings are Romabond polyester.

WORKING PRESSURE: Up to 350 PSI.



**ALPHA XL
FITS DUCTILE IRON THROUGH
OVERSIZE CAST IRON PIPE OD'S.**



Certified to
NSF/ANSI 61 & 372



ALPHA XL™ RESTRAINED JOINT

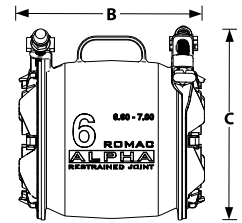
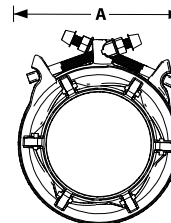

NOM. PIPE SIZE	O.D. RANGE (inches)	CATALOG NUMBER	DIMENSIONS			LIST PRICE	AP-PROX. WEIGHT (lbs)
			A O.D.	B LENGTH	C HEIGHT		
4"	4.80 - 5.10	ALPHA XL - 5.10	8.10	11.80	9.80	\$704.06	40
6"	6.90 - 7.10	ALPHA XL- 7.10	10.40	12.00	12.00	969.70	50
8"	9.05 - 9.40	ALPHA XL - 9.40	13.50	13.20	15.10	1,252.43	75
10"	11.10 - 11.45	ALPHA XL - 11.45	15.60	13.20	17.20	1,589.79	95
12"	13.20 - 13.60	ALPHA XL - 13.60	17.60	13.30	19.20	1,871.71	100
*16"	17.40 - 17.85	ALPHA XL - 17.85	23.60	15.30	25.50	5,543.95	230

* 16" is not compatible with HDPE pipe

TO ORDER: Determine the O.D. of the pipes to be coupled, and select coupling size which covers the pipe diameters of both pipe ends. Example: To couple 8" Oversize Cast Iron Pipe and 8" C900 PVC pipe, order **ALPHA-XL- 9.40**.

ALPHA™ TC

WIDE RANGE TRANSITION RESTRAINED COUPLING



MATERIAL SPECIFICATIONS

CASTINGS: All cast components (end rings, center ring and bolt guides) are ductile iron, meeting or exceeding the requirements of ASTM A536, grade 65-45-12.

GRIPPERS: Ductile (nodular) iron, meeting or exceeding ASTM A536, grade 65-45-12. Machine sharpened and heat treated. Xylan 1424 coating for corrosion protection.

GASKETS: 4"-12" NBR. Gaskets compounded for water and sewer service in accordance with ASTM D2000. NSF/ANSI 61 & 372 Certified.

DRAW-HOOK FASTENERS: 304L stainless steel.

RAMP RUNNERS: Reinforced nylon.

BOLTS & NUTS: 304 stainless steel, 5/8-11 bolts with heavy hex e-coated nuts. Fasteners provided with anti-galling protection. 316 stainless steel available by request.

COATINGS: Center ring Romacoat fusion bonded epoxy, NSF 61 certified. End rings are Romabond polyester.

WORKING PRESSURE: Up to 350 PSI.



Certified to
NSF/ANSI 61 & 372

ALPHA TC
FITS IPS THROUGH OVERSIZE
CAST IRON PIPE OD'S.



ALPHA TC™

RESTRAINED JOINT

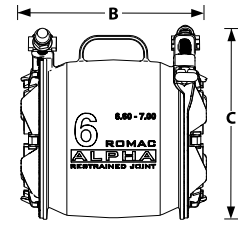
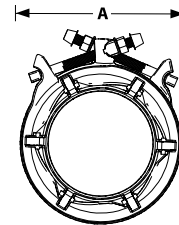

NOM. PIPE SIZE	O.D. RANGE (inches)	CATALOG NUMBER	DIMENSIONS			LIST PRICE	AP- PROX. WEIGHT (lbs)
			A O.D.	B LENGTH	C HEIGHT		
4"	4.80-5.10 x 4.50-4.90	ALPHA TC - 5.10 x 4.90	8.10	11.80	9.80	\$697.30	40
6"	6.90-7.10 x 6.60-7.00	ALPHA TC- 7.10 x 7.00	10.40	12.00	12.00	960.37	50
8"	9.05-9.40 x 8.60-9.10	ALPHA TC - 9.40 x 9.10	13.50	13.20	15.10	1,240.39	75
10"	11.10-11.45 x 10.75-11.20	ALPHA TC - 11.45 x 11.20	15.60	13.20	17.20	1,574.51	95
12"	13.20-13.60 x 12.75-13.30	ALPHA TC - 13.60 x 13.30	17.60	13.30	19.20	1,853.71	100

TO ORDER: Determine the O.D. of the pipes to be coupled, and select coupling size which covers the pipe diameters of both pipe ends. Example: To couple 8" Oversize Cast Iron Pipe and 8" C900 PVC pipe, order **ALPHA TC - 9.40 x 9.10**.



ALPHA™ END CAP RESTRAINED END CAP

MATERIAL SPECIFICATIONS

CASTINGS: All cast components (end rings, center ring and bolt guides) are ductile iron, meeting or exceeding the requirements of ASTM A536, grade 65-45-12.

GRIPPERS: Ductile (nodular) iron, meeting or exceeding ASTM A536, grade 65-45-12. Machine sharpened and heat treated. Xylan 1424 coated for corrosion protection.

GASKET: SBR compounded for water and sewer service in accordance with ASTM D2000. NBR available upon request. NSF/ANSI 61 & 372 Certified.

DRAW-HOOK FASTENERS: 304L stainless steel.

RAMP RUNNERS: Reinforced nylon.

BOLT & NUT: R-Blue. HSLA. Xylan coated to reduce friction and provide corrosion resistance. For details, see catalog page 10-3.

WASHER: 304 Stainless steel.

COATINGS: End cap Romacoat fusion bonded epoxy, NSF 61 certified. End rings are Romabond polyester.

WORKING PRESSURE: Up to 350 PSI.



Certified to NSF/ANSI 61 & 372

STANDARD ALPHA END CAP
FITS IPS PVC THROUGH
DUCTILE IRON PIPE OD'S.

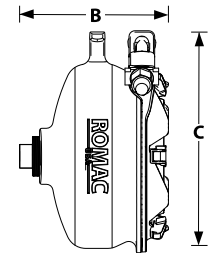
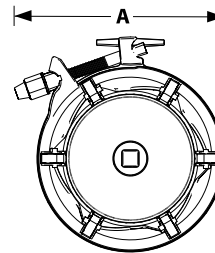

NOM. PIPE SIZE	O.D. RANGE (inches)	CATALOG NUMBER	DIMENSIONS			LIST PRICE	AP-PROX. WEIGHT (lbs)
			A O.D.	B LENGTH	C HEIGHT		
4"	4.50 - 4.90	ALPHA-EC - 4.90	8.10	7.40	9.80	\$480.45	21
6"	6.60 - 7.00	ALPHA-EC - 7.00	10.40	7.90	12.00	616.50	30
8"	8.60 - 9.10	ALPHA-EC - 9.10	13.40	9.70	15.10	862.17	52
10"	10.75 - 11.20	ALPHA-EC - 11.20	15.50	9.90	17.10	1,347.77	63
12"	12.75 - 13.30	ALPHA-EC - 13.30	17.50	10.30	19.20	1,507.19	78

TO ORDER: Determine the O.D. of the pipe to be capped, and select end cap size which covers the pipe diameter. Specify Catalog Number. **EXAMPLE:** To cap an 8" DI or 8" IPS PVC pipe, order **ALPHA-EC - 9.10**

MATERIAL SPECIFICATIONS

CASTINGS: All cast components (end rings, center ring and bolt guides) are ductile iron, meeting or exceeding the requirements of ASTM A536, grade 65-45-12.

GRIPPERS: Ductile (nodular) iron, meeting or exceeding ASTM A536, grade 65-45-12. Machine sharpened and heat treated. Xylan 1424 coated for corrosion protection.

GASKETS: 4"-12" NBR; 16" SBR. Gaskets compounded for water and sewer service in accordance with ASTM D2000. NSF/ANSI 61 & 372 Certified.

DRAW-HOOK FASTENERS: 304L stainless steel.

RAMP RUNNERS: Reinforced nylon.

BOLT & NUT: R-Blue. HSLA. Xylan coated to reduce friction and provide corrosion resistance. For details, see catalog page 10-3.

WASHER: 304 Stainless steel.

COATINGS: End cap Romacoat fusion bonded epoxy, NSF 61 certified. End rings are Romabond polyester.

WORKING PRESSURE: Up to 350 PSI.

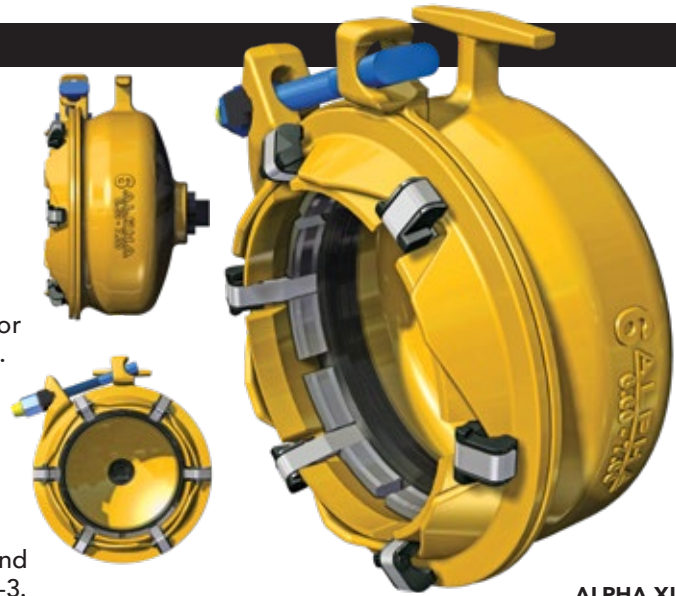

ALPHA XL
FITS DUCTILE IRON THROUGH
OVERSIZE CAST IRON PIPE OD'S.



Certified to
NSF/ANSI 61 & 372

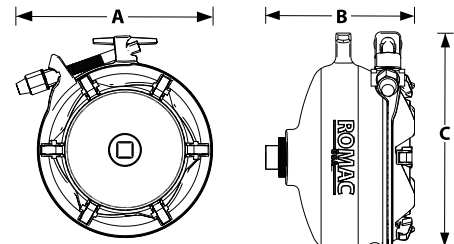

ALPHA XL™

RESTRAINED END CAP

NOM. PIPE SIZE	O.D. RANGE (inches)	CATALOG NUMBER	DIMENSIONS			LIST PRICE	AP-PROX. WEIGHT (lbs)
			A O.D.	B LENGTH	C HEIGHT		
4"	4.80 - 5.10	ALPHA EC XL - 5.10	8.10	7.40	9.80	\$490.04	21
6"	6.90 - 7.10	ALPHA EC XL - 7.10	10.40	7.90	12.00	628.84	30
8"	9.05 - 9.40	ALPHA EC XL - 9.40	13.40	9.70	15.10	879.42	52
10"	11.10 - 11.45	ALPHA EC XL - 11.45	15.50	9.90	17.10	1,374.72	63
12"	13.20 - 13.60	ALPHA EC XL - 13.60	17.50	10.30	19.20	1,537.33	78
*16"	17.40 - 17.85	ALPHA EC XL - 17.85	23.70	12.00	25.60	4,642.84	180

* 16" is not compatible with HDPE pipe

TO ORDER: Determine the O.D. of the pipe to be capped, and select end cap size which covers the pipe diameter. Specify Catalog Number. **EXAMPLE:** To cap an 8" DI or 8" Cast Iron pipe, order **ALPHA-EC-XL -9.40**



ALPHA™ FC RESTRAINED FLANGED COUPLING

MATERIAL SPECIFICATIONS

CASTINGS: All cast components (end rings, center ring and bolt guides) are ductile iron, meeting or exceeding the requirements of ASTM A536, grade 65-45-12.

FLANGE: Compatible with flat face flanges with ANSI Class 125 and 150 bolt circles. See page 10-6 for filler flange.

GRIPPERS: Ductile (nodular) iron, meeting or exceeding ASTM A536, grade 65-45-12. Machine sharpened and heat treated. Xylan 1424 coated for corrosion protection.

GASKET: SBR compounded for water and sewer service in accordance with ASTM D2000. NBR available upon request. NSF/ANSI 61 & 372 Certified.

DRAW-HOOK FASTENERS: 304L stainless steel.

RAMP RUNNERS: Reinforced nylon.

BOLT & NUT: 304 stainless steel, 5/8-11 bolts with heavy hex e-coated nuts. Fasteners provided with anti-galling protection.

WASHER: 304 Stainless steel.

COATINGS: Flanged coupling Romacoat fusion bonded epoxy, NSF 61 certified. End rings are Romabond polyester.

WORKING PRESSURE: Up to 350 PSI.



STANDARD ALPHA FC
FITS IPS PVC THROUGH
DUCTILE IRON PIPE OD'S.



Certified to
NSF/ANSI 61 & 372



ALPHA™ FC

RESTRAINED FLANGED COUPLING

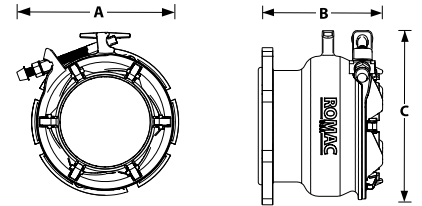

NOM. PIPE SIZE	O.D. RANGE (inches)	CATALOG NUMBER	DIMENSIONS			LIST PRICE	AP-PROX. WEIGHT (lbs)
			A O.D.	B LENGTH	C HEIGHT		
4"	4.50 - 4.90	ALPHA-FC - 4.90	11.20	8.15	10.25	\$685.10	29
6"	6.60 - 7.00	ALPHA-FC - 7.00	11.35	8.24	12.45	704.53	40
8"	8.60 - 9.10	ALPHA-FC - 9.10	13.40	9.96	15.55	885.56	57
10"	10.75 - 11.20	ALPHA-FC - 11.20	15.45	10.18	17.65	1,406.43	82
12"	12.75 - 13.30	ALPHA-FC - 13.30	17.50	10.28	19.70	1,575.69	105

TO ORDER: Determine the O.D. of the pipes to be coupled. Specify Catalog Number.

EXAMPLE: To couple an 8" DI or 8" IPS PVC pipe, order **ALPHA-FC -9.10**

MATERIAL SPECIFICATIONS

CASTINGS: All cast components (end rings, center ring and bolt guides) are ductile iron, meeting or exceeding the requirements of ASTM A536, grade 65-45-12.

FLANGE: Compatible with flat face flanges with ANSI Class 125 and 150 bolt circles. See page 10-6 for filler flange.

GRIPPERS: Ductile (nodular) iron, meeting or exceeding ASTM A536, grade 65-45-12. Machine sharpened and heat treated. Xylan 1424 coated for corrosion protection.

GASKETS: NBR compounded for water and sewer service in accordance with ASTM D2000. NSF/ANSI 61 & 372 Certified.

DRAW-HOOK FASTENERS: 304L stainless steel.

RAMP RUNNERS: Reinforced nylon.

BOLT & NUT: 304 stainless steel, 5/8-11 bolts with heavy hex e-coated nuts. Fasteners provided with anti-galling protection.

WASHER: 304 Stainless steel.

COATINGS: Flanged coupling body Romacoat fusion bonded epoxy, NSF 61 certified. End rings are Romabond polyester.

WORKING PRESSURE: Up to 350 PSI.



ALPHA XL FC
FITS DUCTILE IRON THROUGH
OVERSIZE CAST IRON PIPE OD'S.



Certified to
NSF/ANSI 61 & 372



ALPHA™ FC

RESTRAINED FLANGED COUPLING

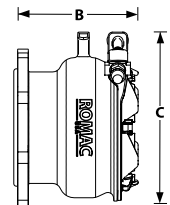
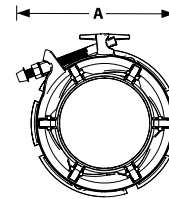

NOM. PIPE SIZE	O.D. RANGE (inches)	CATALOG NUMBER	DIMENSIONS			LIST PRICE	AP-PROX. WEIGHT (lbs)
			A O.D.	B LENGTH	C HEIGHT		
4"	4.80 - 5.10	ALPHA FC XL - 5.10	11.20	8.15	10.25	\$698.78	29
6"	6.90 - 7.10	ALPHA FC XL- 7.10	11.35	8.24	12.45	718.61	40
8"	9.05 - 9.40	ALPHA FC XL - 9.40	13.40	9.96	15.55	903.28	57
10"	11.10 - 11.45	ALPHA FC XL - 11.45	15.45	10.18	17.65	1,434.55	82
12"	13.20 - 13.60	ALPHA FC XL - 13.60	17.50	10.28	19.70	1,607.19	105

TO ORDER: Determine the O.D. of the pipes to be coupled. Specify Alpha Catalog Number.

EXAMPLE: To couple an 8" DI or 8" cast iron pipe, order **ALPHA-FC-XL-9.40**

ALPHA™ TEE RESTRAINED FITTING



MATERIAL SPECIFICATIONS

CASTINGS: All cast components (end rings, center ring, and bolt guides) are ductile iron, meeting or exceeding the requirements of ASTM A536, grade 65-45-12.

GRIPPERS: Ductile (nodular) iron, meeting or exceeding ASTM A536, Grade 65-45-12. Machine sharpened and heat treated. Xylan 1424 coated for superior corrosion resistance.

GASKETS: SBR compounded for water and sewer service per ASTM D2000, classified by UL to meet NSF61 or NBR compounded for water and sewer service per ASTM D2000, NSF61 Certified.

DRAW HOOKS: Uncoated 304 stainless steel.

RAMP RUNNERS: Reinforced nylon.

BOLTS AND NUTS: R-Blue. 5/8-11 bolts with heavy hex nuts. Xylan coated to reduce friction and provide corrosion resistance. Washer is 304 stainless steel.

COATINGS: Center ring is Romacoat fusion bonded epoxy, NSF 61 certified. End rings are Romabond polyester.



ALPHA™ TEE

RESTRAINED FITTING

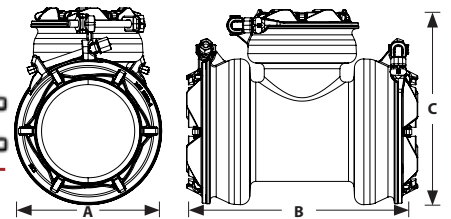

NOM. PIPE SIZE	O.D. RANGE (inches)	O.D. RANGE BRANCH (inches)	CATALOG NUMBER	DIMENSIONS			LIST PRICE	AP-PROX. WEIGHT (lbs)
				A O.D.	B LENGTH	C HEIGHT		
6x6x6	6.60 - 7.00	6.60 - 7.00	ALPHA-TEE - 7.00 x 7.00	10.33	19.28	14.59	\$1,275.56	90
8x8x6	8.60 - 9.10	6.60 - 7.00	ALPHA-TEE - 9.10 x 7.00	13.29	21.09	17.78	1,560.59	135
10x10x6	10.75 - 11.20	6.60 - 7.00	ALPHA-TEE - 11.20 x 7.00	15.40	21.71	19.84	2,158.86	155
12x12x6	12.75 - 13.30	6.60 - 7.00	ALPHA-TEE - 13.30 x 7.00	17.52	23.52	21.15	2,726.09	180

TO ORDER: Determine the O.D. of the pipes to be coupled. Specify Catalog Number.

EXAMPLE: For a tee with an 8" DI or 8" IPS PVC run and a 6" DI or IPS PVC branch, order **ALPHA-TEE - 9.10 x 7.00**